

Presentation of SPICA

Stellar **P**arameters and **I**mages with a **C**ophased **A**rray

Development phase

- Funded by UCA, OCA, CNRS, Région Sud between 2017 and 2020
- Funding for the R&D around Integrated Optics for SPICA-FT and funding for the realization of the instruments
- Team involved:
 - DM as PI, Philippe Bério as project manager
 - Julien Dejonghe as optomechanical engineer and main designer
 - Cyril Pannetier (PhD): spectrograph design and spica-ft algorithm
 - Christophe Bailet as mechanical engineer
 - Daniel Lecron, low level electronics and software
 - Frédéric Morand, high level and detector software
 - Sylvain Rousseau, spica-ft software
 - Stéphane Lagarde, system
 - Fatmé Allouche, Alain Spang as support for integration and tests

Integration on CHARA/mt Wilson



SPICA in a nutshell

- A H-band 6T-ABCD fringe sensor aiming at performing group delay and phase delay tracking of the fringes.
- A All-In-One 6T combiner (600-900nm) with 3 dispersion modes and spatial filtering with monomode fibers

MODES	Nb of SpCh	SpCh	Spectral Band	MagLim $V^2=0.6$	MagLim $V^2=0.6 + FT$	MagLim Vdiff	MagLim Vdiff+FT
LR: R=140	60	~5nm	300nm	8.5	11.5		
MR: R=4400	500	0.17nm	85nm			5.5	9.5
HR: R=13000	500	0.06nm	29nm			4.5	8.5

MagLim: V^2 : SNR=10, 10mn of integration, for one spectral channel

Vdiff: [SNR=10, $\sigma\phi < 5^\circ$], $V^2=0.6$ in the reference channel, 30mn of integration, for one spectral channel

*SNR calculator based on FRIEND calibration (Martinod+2018), CHARA-AO hypothesis (SR=20%), SPICA estimations
Validation to be done on sky in 2022*

Integration on CHARA/mt Wilson

Details of the dispersion system

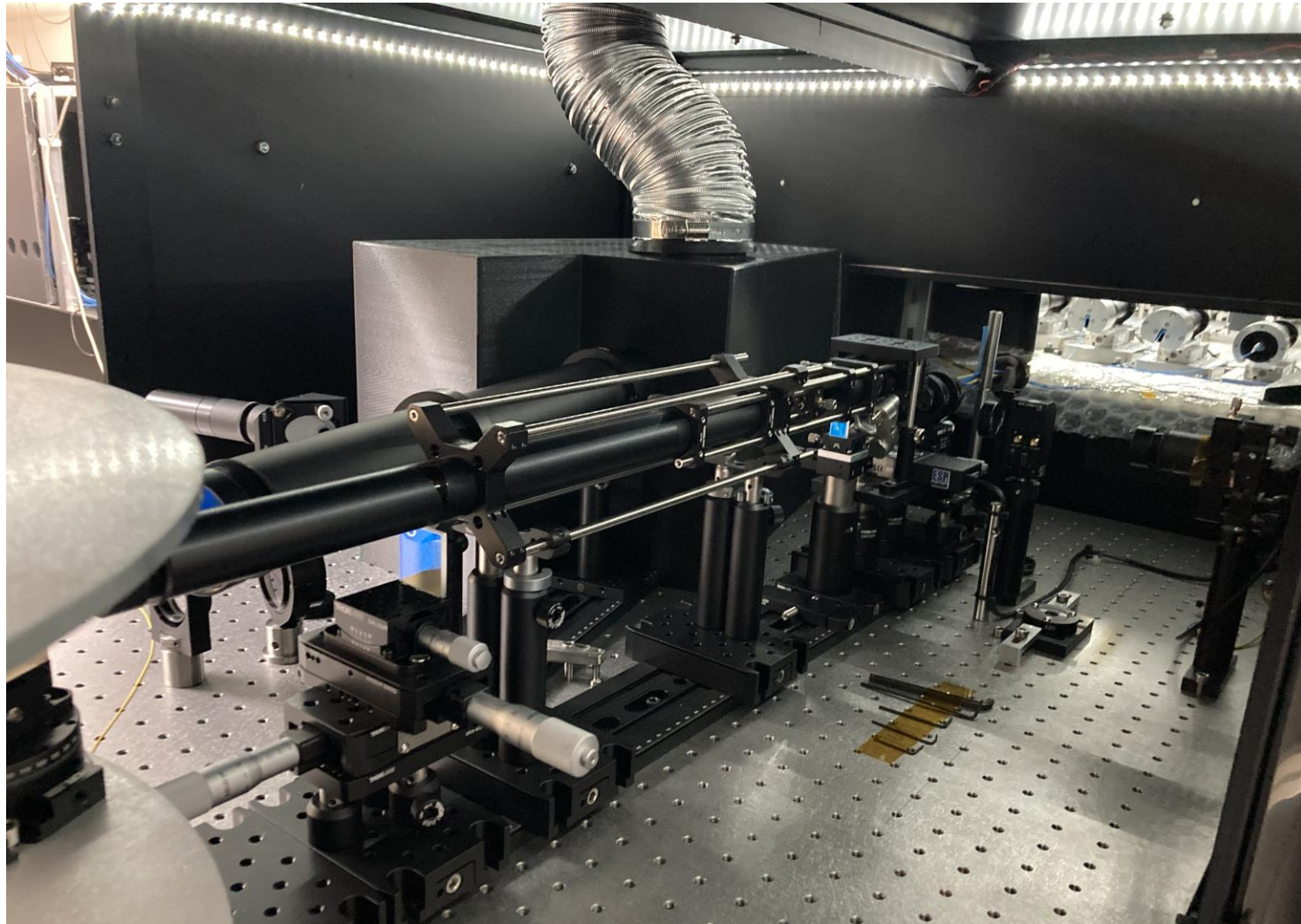

General view of the spectrograph table

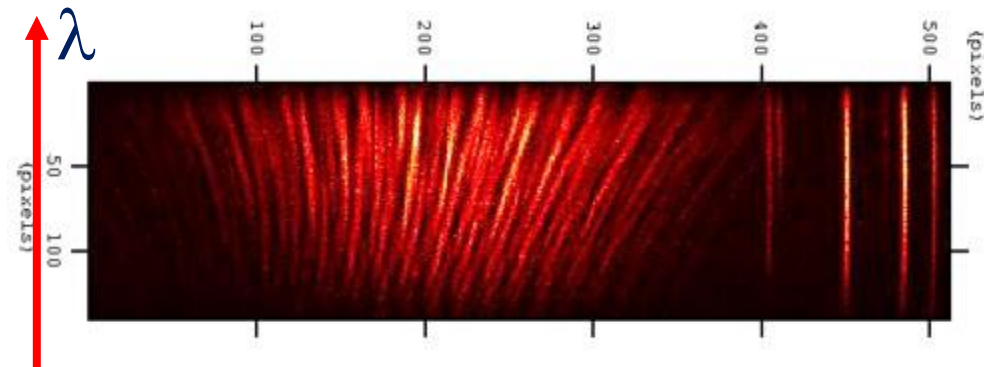
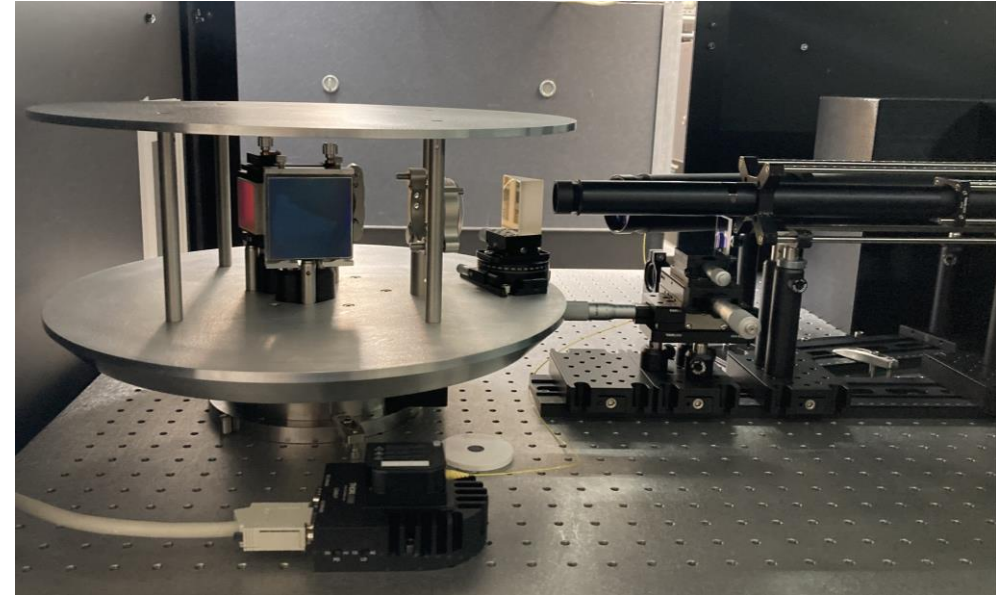

Interferometric beam and 6 photometric beams

Spatio-spectral encoding of SPICA-VIS

Spatial modulation(X)

Encoding 15 different spatial frequencies

Pupil plane – 6 fibers

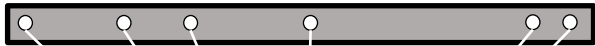
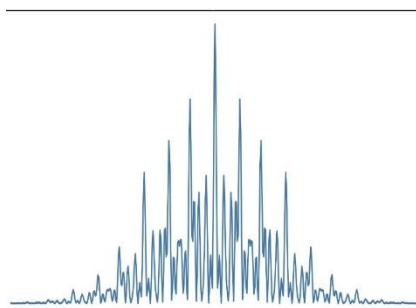

Image Plane recombinaison

Intensity



1D, monochromatic interferogram

$|TF|^2$

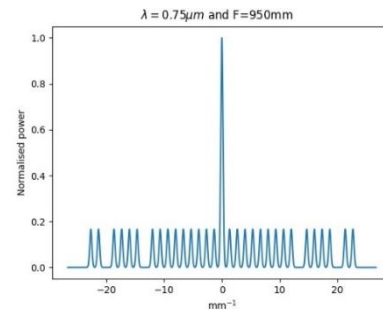

DSP of the interferogram



Spectral dispersion (Y)

$$\lambda F/D \approx 2 \text{ pixels}$$



Anamorphosis

$$\frac{ON_Y}{ON_X} > 60$$

X Y

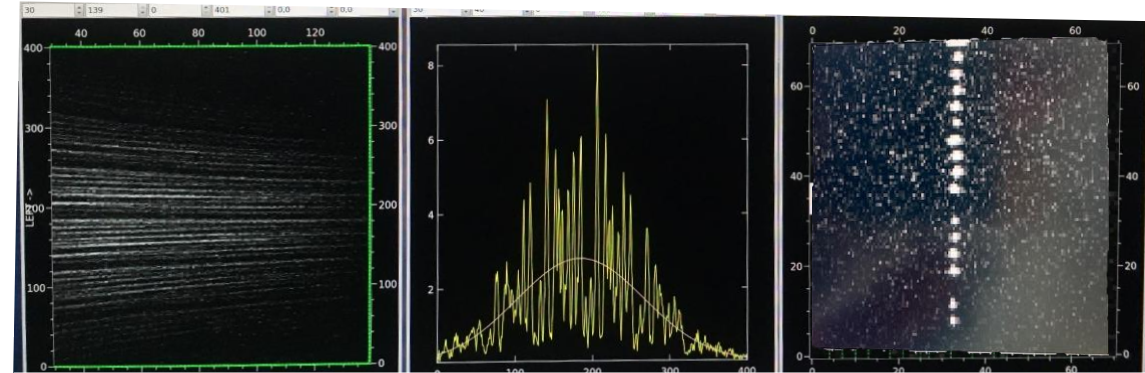

Situation of the spectrograph

- Change of V-groove (and its mounting) during the winter to improve the superposition of the interferometric beams and to reduce the diffraction of the gaussian beams by the microlens array. → action closed
- Modification of the second cylindrical lens to reduce the chromatic aberrations. → action closed
- Modification of the cooling of the detector to avoid overheating and security alarms or cooling shutdown.
- Stability checks (see QC plots by Philippe later today)

How to (correctly) feed SPICA-VIS spectrograph...

New injection modules developed by Julien during the winter to include a focalization level

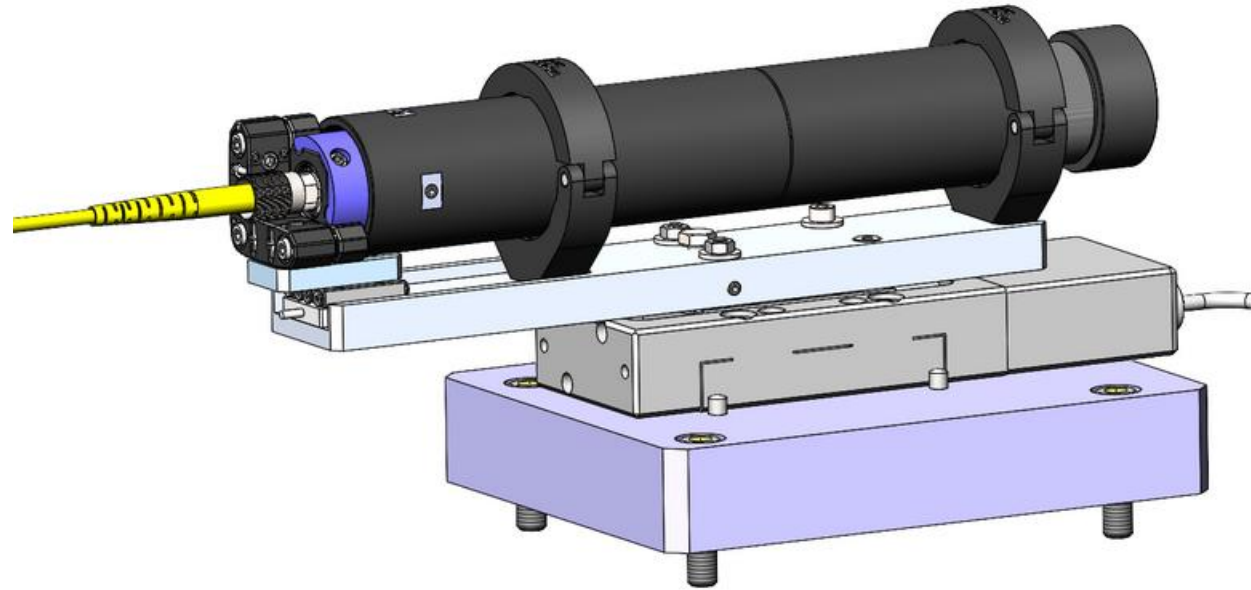

The injection modules are mounted on translation stages, acting as differential delay lines to phase the IR instrument and SPICA-VIS

Optimization of the focus of the fiber injection modules

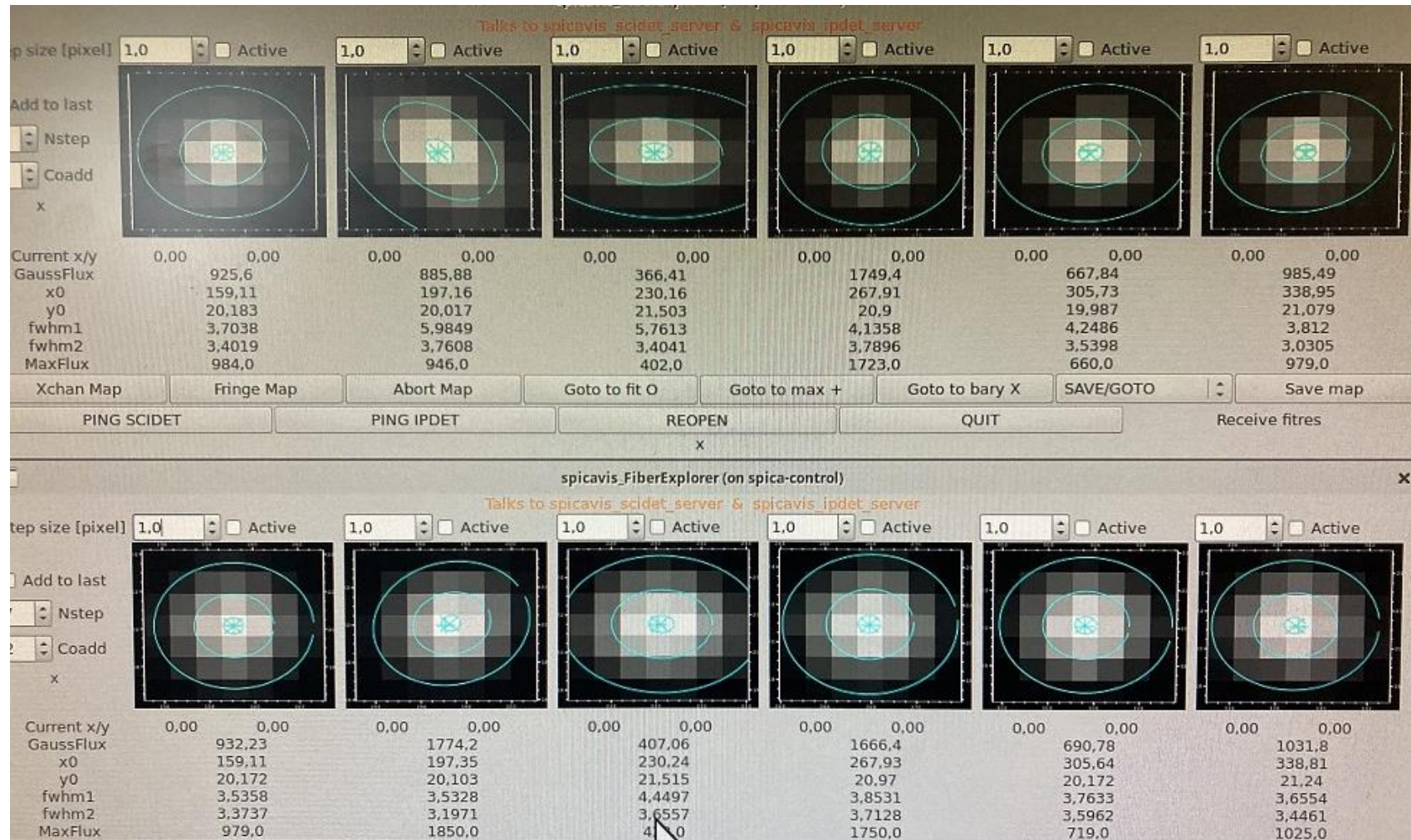

→ Clear improvement (bottom sequence): B3 could maybe be improved further

Feeding the injection modules

1. 3 translations: focus of the fiber and XY to align the pupil on the entrance of the injection module
2. 1 additional device to correctly reimaging the CHARA pupils
3. 2 rotations: to adjust the tip/tilt of the beams on the axis of the injection module + fast actuators on small strokes to compensate the residuals of the AO correction
4. 1 rotation of the fiber to align the polarization of all the fibers (done on the positioning of the fiber connector)
5. Compensation of differential polarization among the fibers by the Polarization Device Compensators
6. Lateral dispersion due to the atmospheric refraction by the SPICA internal Atmospheric Dispersion Compensation (not yet operational)
7. Longitudinal dispersion due to the difference of air paths by the LDC, VLDC and Differential Delay Lines

SPICA-VIS injection table

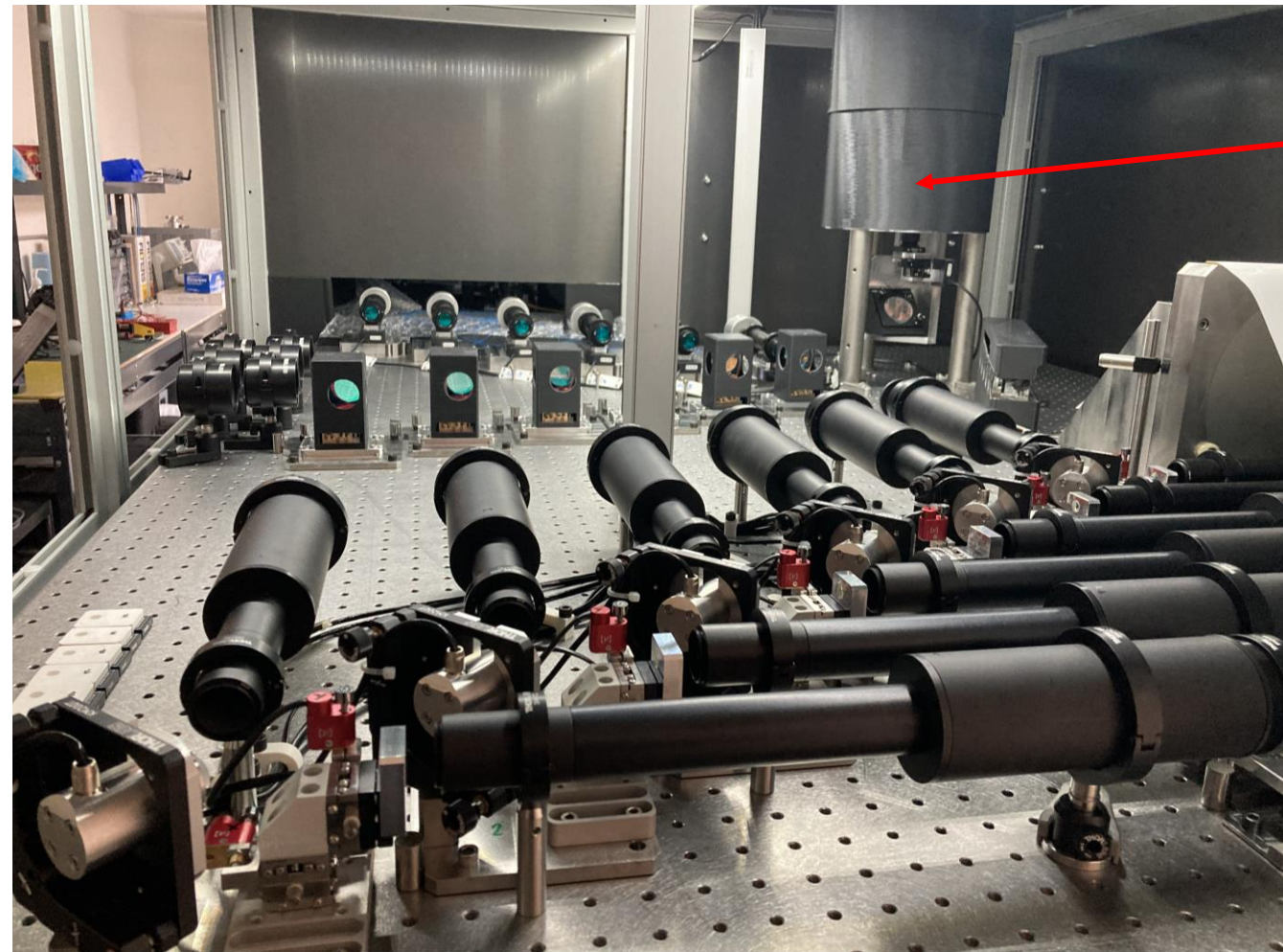

Control detector for Image plane or Pupil plane viewing. Reference positions defined by the Fiber Back Illumination

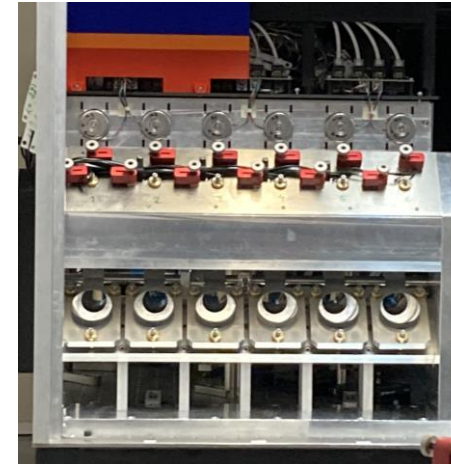

SPICA periscope with IMG mirrors and ADC

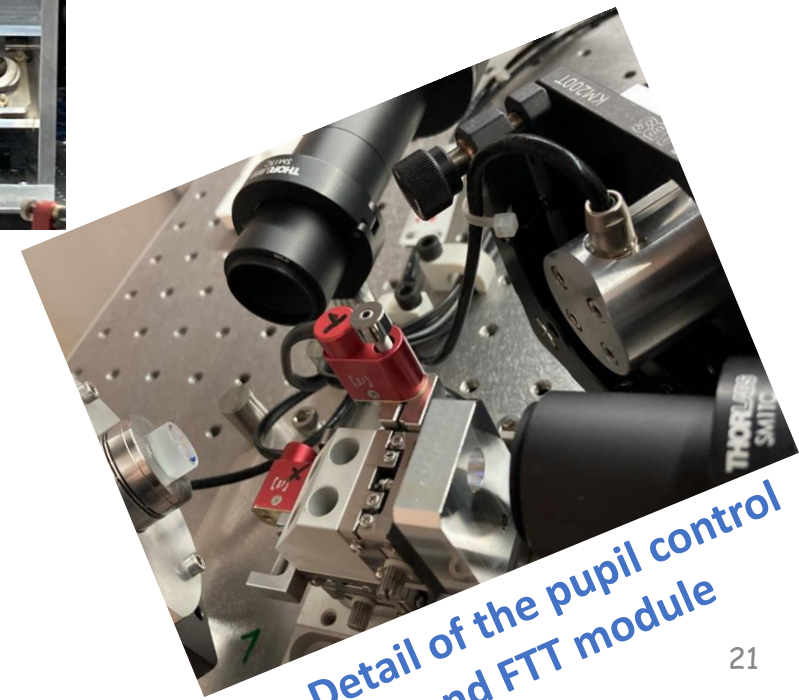

Detail of the pupil control and FFT module

Feeding the injection modules

1. 3 translations: focus of the fiber and XY to align the fiber with the entrance of the injection module
2. 1 additional device to correctly reimage the CHARA pupil
3. 2 rotations: to adjust the tip/tilt of the beams on the detector module + fast actuators on small strokes to compensate for atmospheric AO correction
4. 1 rotation of the fiber to align the polarization of all the fibers (done on the positioning of the fiber connector)
5. **Compensation of differential polarization among the fibers by the Polarization Device Compensators**
6. Lateral dispersion due to the atmospheric refraction by the SPICA internal Atmospheric Dispersion Compensation (not yet operational)
7. Longitudinal dispersion due to the difference of air paths by the LDC, VLDC and Differential Delay Lines

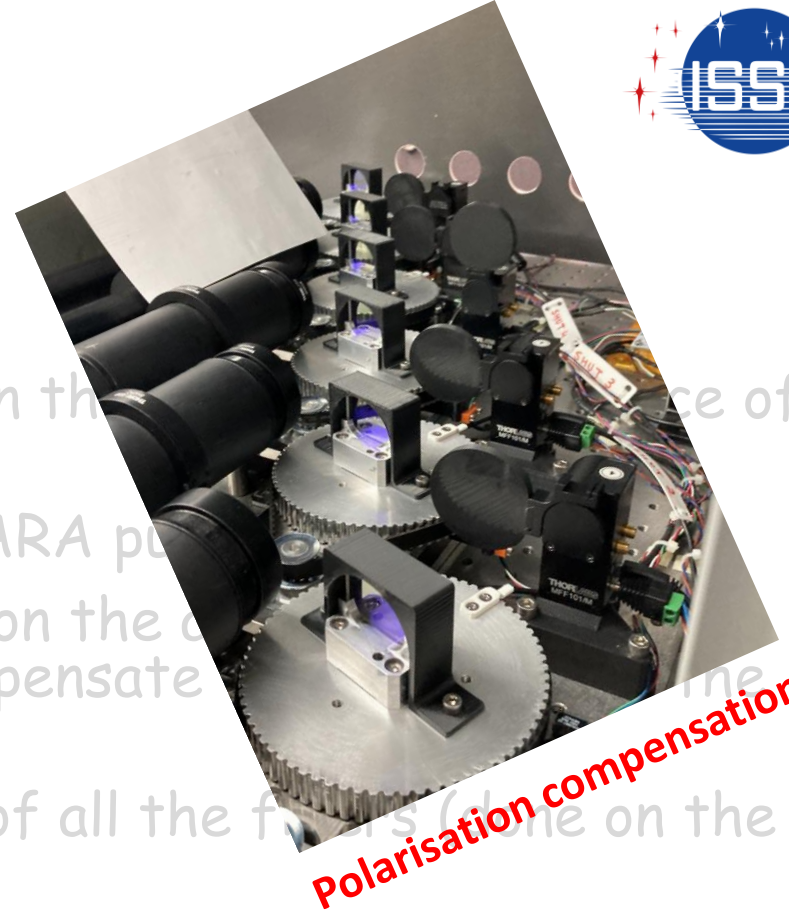

Compensation of polarization (PDC result)

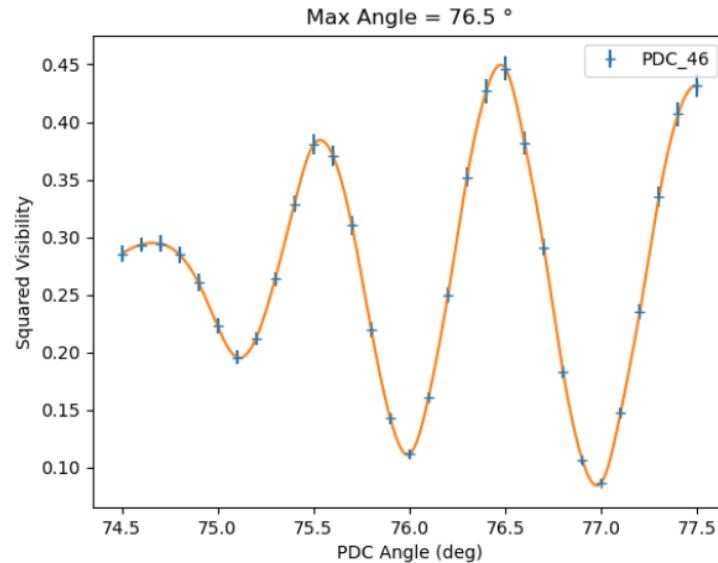
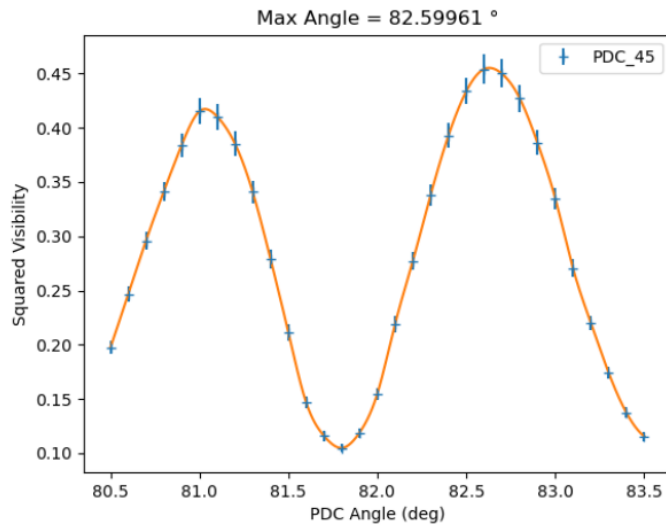
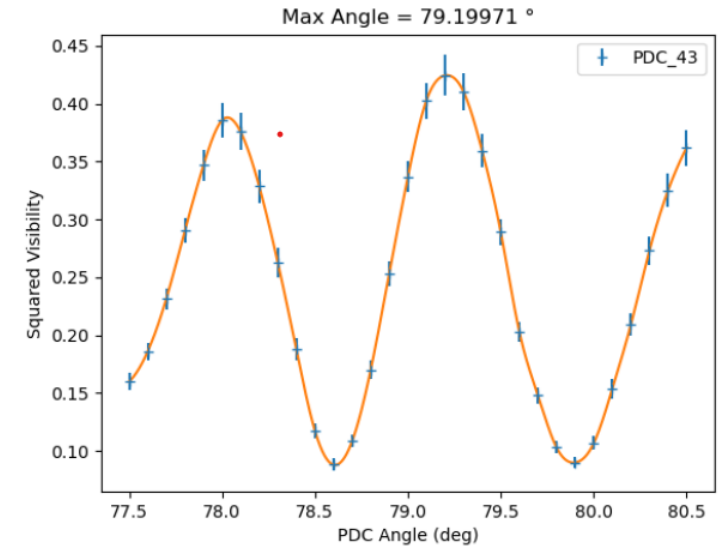
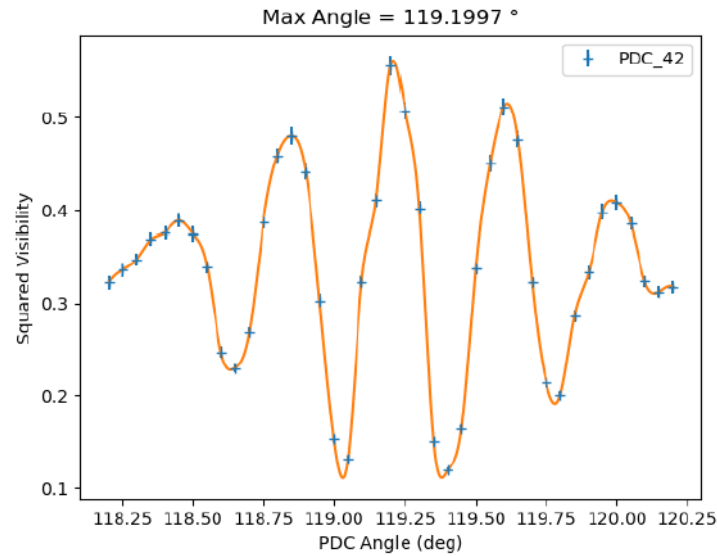
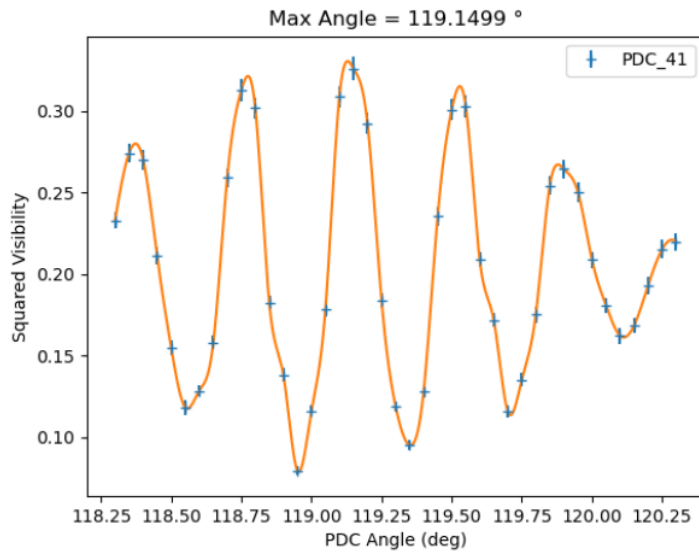

Solution found but:

- Nonlinearity of the motion below 0.1°
- Improvement of the 0 and of the quality of the motion
- All PDC validated wrt B4 but maybe optimization not perfect on other pairs.

STS results

V^2

Diff Phase

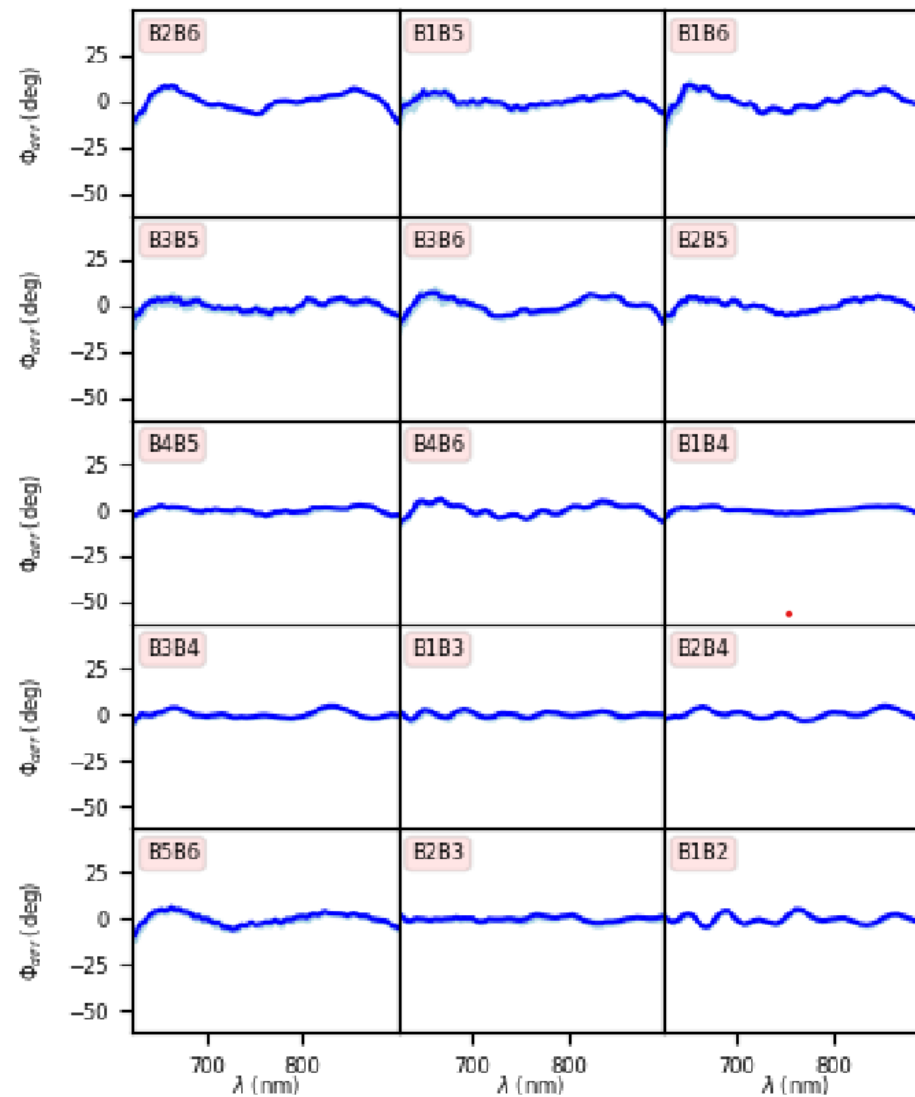
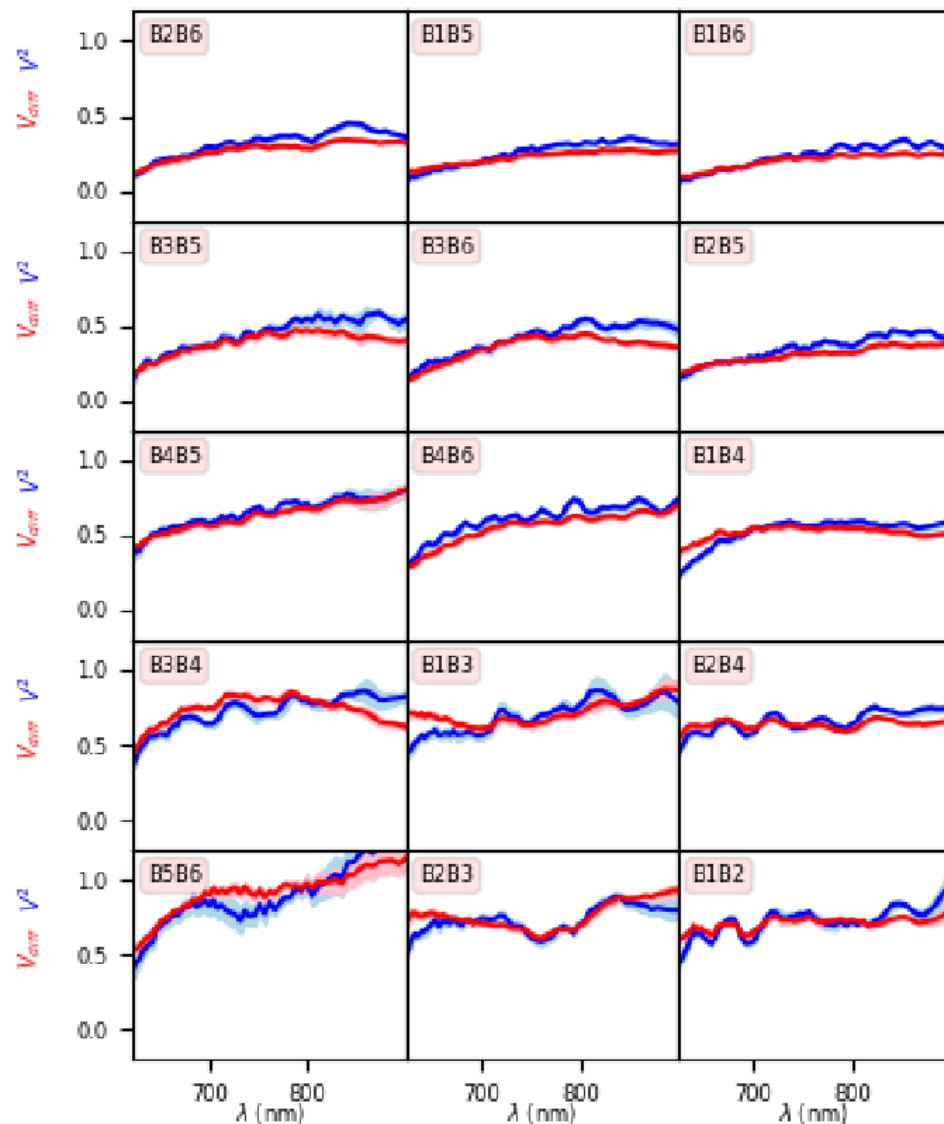

Lateral dispersion compensation

1. 3 translations: focus of the fiber and XY to align the injection module
2. 1 additional device to correctly reimage the CHAF
3. 2 rotations: to adjust the tip/tilt of the beams module + fast actuators on small strokes to correct AO correction
4. 1 rotation of the fiber to align the polarization of all the (positioning of the fiber connector)
5. Compensation of differential polarization among the fibers by the Polarization Device Compensators
6. **Lateral dispersion due to the atmospheric refraction by the SPICA internal Atmospheric Dispersion Compensation (not yet operational)**
7. Longitudinal dispersion due to the difference of air paths by the LDC, VLDC and Differential Delay Lines

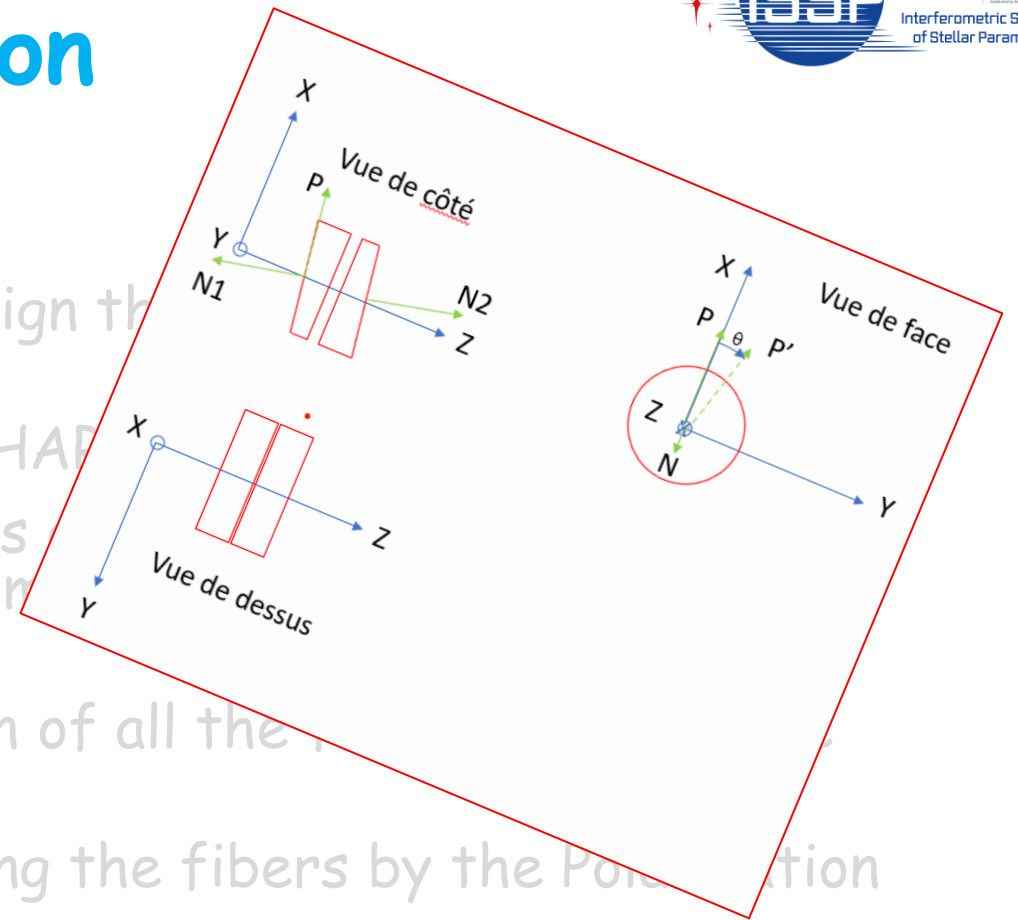

Lateral dispersion issues on SKY

- This effect is very classical and is called the atmospheric refraction.
 - $Z=30^\circ$: 0.15" between $0.65\mu\text{m}$ and $0.85\mu\text{m}$
 - $Z=60^\circ$: 0,41" between $0.65\mu\text{m}$ and $0.85\mu\text{m}$
 - Correction needed to avoid a strong loss of injection in the large spectral band of SPICA
 - ADC is a simple and well-known device
- But....
 - In the lab the direction of refraction is rotating with the field rotation
 - The simplest design of ADC generates a deviation when the angle of correction is changed
- Results
 - Full model done and validated.
 - Control of ADC is operational.
 - Some pieces of software for on-sky operation are needed.
- Not yet commissioned on sky but validated through optical simulations in lab with STS.

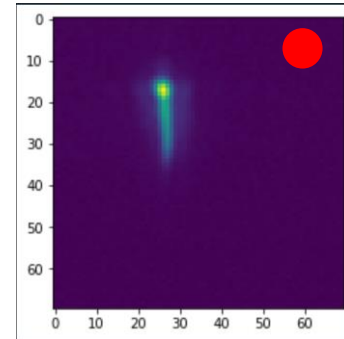

Longitudinal dispersion compensation

1. 3 translations: focus of the fiber and XY to the entrance of the injection module
2. 1 additional device to correctly reimage the fiber
3. 2 rotations: to adjust the tip/tilt of the fiber + fast actuators on small stroke for AO correction
4. 1 rotation of the fiber to align the polarization (independent of the positioning of the fiber connector)
5. Compensation of differential polarization among the fibers by using Wave Plate Compensators
6. Lateral dispersion due to the atmospheric refraction by the SPICA internal Atmospheric Dispersion Compensation (not yet operational)
7. Longitudinal dispersion due to the difference of air paths by the LDC, VLDC and Differential Delay Lines

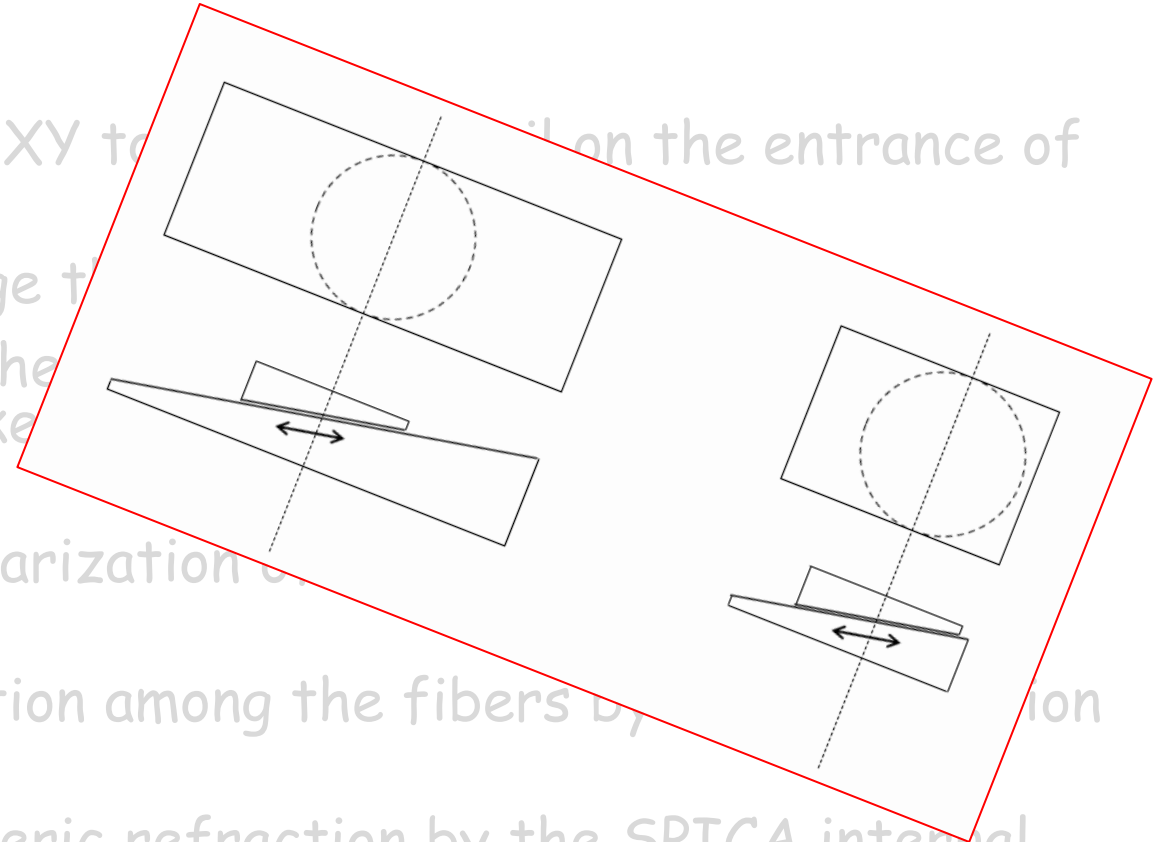

LDC - situation

- Because the main delay lines of CHARA are operated in air, differential air paths and the chromatism of the refraction index of air generate chromatic optical path differences
- Different chromatic effects
 - Between H band (SPICA-FT) and R band (SPICA-VIS)
 - Within the H band (1.4-1.65 μm)
 - Within the SPICA band (0.6 - 0.9 μm)
- A single glass correction is not optimal →
 - The common CHARA LDCs are set to optimize the correction in the H band
 - Visible LDCs (only seen by the visible beams) adapt the LDC correction to the visible band.
 - The SPICA DDL compensate for the mean H-R band difference of optical paths
- Full model established by Cyril during his PhD (Pannetier + 2021, MNRAS)

LDC - implementation

- Linear relations between difference of air paths and LDC, VLDC thickness, and DDL offset.
- But air paths are calculated by OPLE server which is overloaded.
 - First attempts (May 2022) were blocking the systems
- Development of a spica_ople server by Narsi (Oct 2022) but many issues:
 - Bad calculations of airpaths (October, November)
 - (no observations in December and March)
 - Many issues encountered in April 2023 with correction stopped and dispersion added
- May 2023: issues found in the code (bad management of the limit strokes) but not yet tested on sky.

→ this is the top priority of SPICA as the Low Resolution operation of SPICA-VIS is critical for sensitivity but requires a good Group Delay Tracking and a stable correction of dispersion to avoid looking for fringes all the time.

Additional aspects on AO

- AO modeling and optimization performed by Pierre together with Matt, Theo and Philippe, Denis & Olivier
 - Characterization of the misregistration (default of alignment of the WFS at the time of operation versus at the time of calibration), and compensation.
 - Development of no-noise synthetic matrix mimicking the CHARA interaction matrix.
 - Development of improved reconstructors MMSE versus SVD.
 - On-sky demonstration of improvement of performance
 - More work to do, also including synthetic matrix calculations based on on-sky reconstructors (recent progresses by Theo and Matt)
 - Characterization of DM commands, WFS telemetry, Control visible images, and Science injected flux.
 - Real time estimation of r_0 through the Zernike projection of the DM commands (in progress)

April, 10 2023 HD184006 injected flux

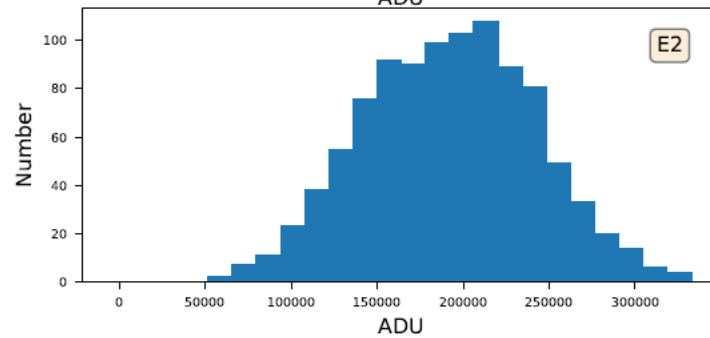
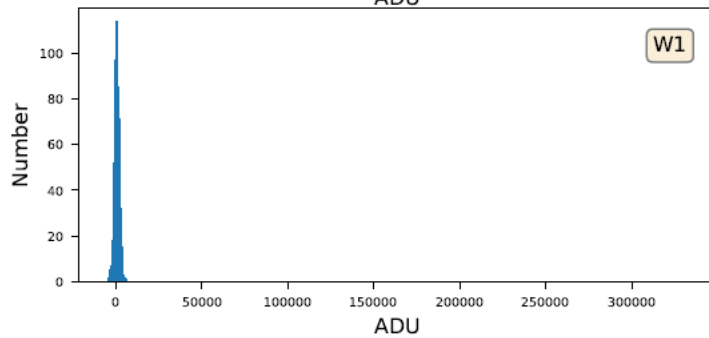
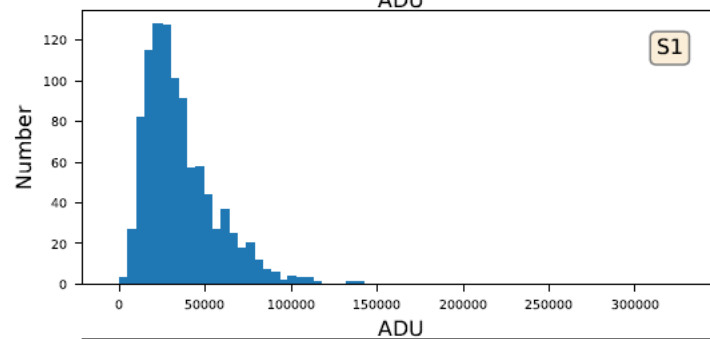
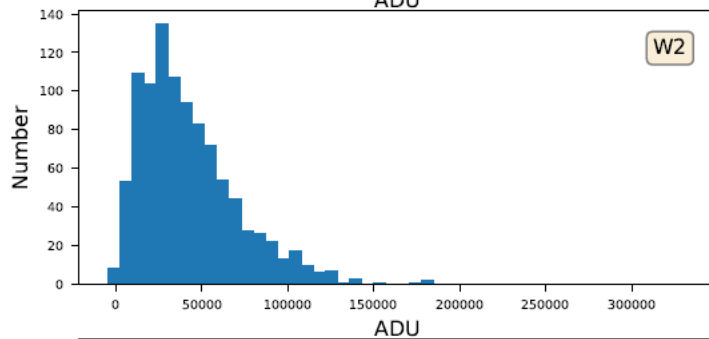
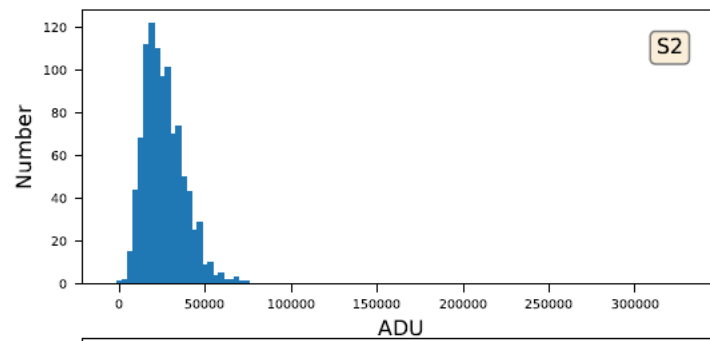
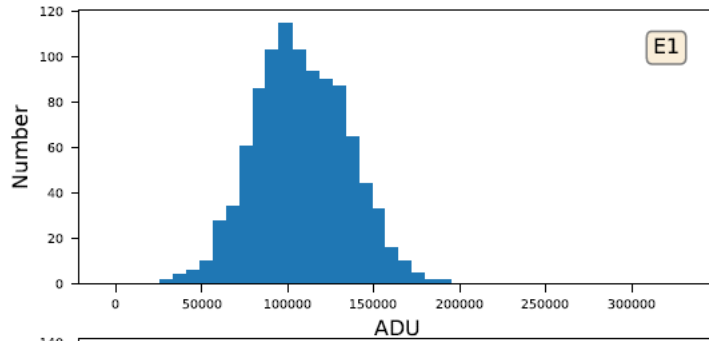

Flux E1 = 106926 +/- 25916

Flux W2 = 36468 +/- 28361

Flux W1 = 517 +/- 1493

Flux S2 = 24012 +/- 11437

Flux S1 = 30198 +/- 20333

Flux E2 = 194001 +/- 49489

Additional aspects on alignment issues

- Tests made in May (on the calibration source) show that the standard CHARA procedure of alignment is correct for SPICA and its visible beams.
- But this alignment is not correctly maintained during tracking and from one slew to another the alignment is not totally reproducible
- Consequences:
 - Loss of time to realign images and pupils on SPICA
 - Saturation of the FTT motions → loss of injection
- Future considerations
 - Consider desaturating the FTT on CHARA alignment and help in maintaining the correct alignment
 - Standard use of SPICA control detector for alignment of beacon
- But dispersion issues (wedge of the telescope dichroics + atmospheric refraction) generates additional complexities, especially when looking for an optimized alignment both in IR (spica-ft) and VIS (spica-vis).

Summary of operations

<https://lagrange.oca.eu/fr/spica-observations>

- Before the start of the night: STS alignment and recording
 - Dark, SPECTRUM, KAPPA, STS6T
- During slewing: set LDC, VLDC, DDL to their expected positions
- When star is locked, align Images and Pupils and start the FTT loops
- Check alignment quality, image quality, and quality of AO corrections through the validation of FTT loops and injected flux
- Lock IR fringes, then look for visible fringes
- Record

Ongoing activities for SPICA-FT (IO device)

- New OAP designed and ordered for optimized injection with the AO correction
- Design of a new fiber switcher to easily accommodate MIRCX-AllInOne and SPICA-FT IO combiner → will replace the current MIRCx injections.
- Motorization of the injection of the IO outputs into the MIRCx spectrograph
- Fabrication in progress – Commissioning programmed in July 2023
- Validation of operation and on-sky qualification of SPICA-FT operations

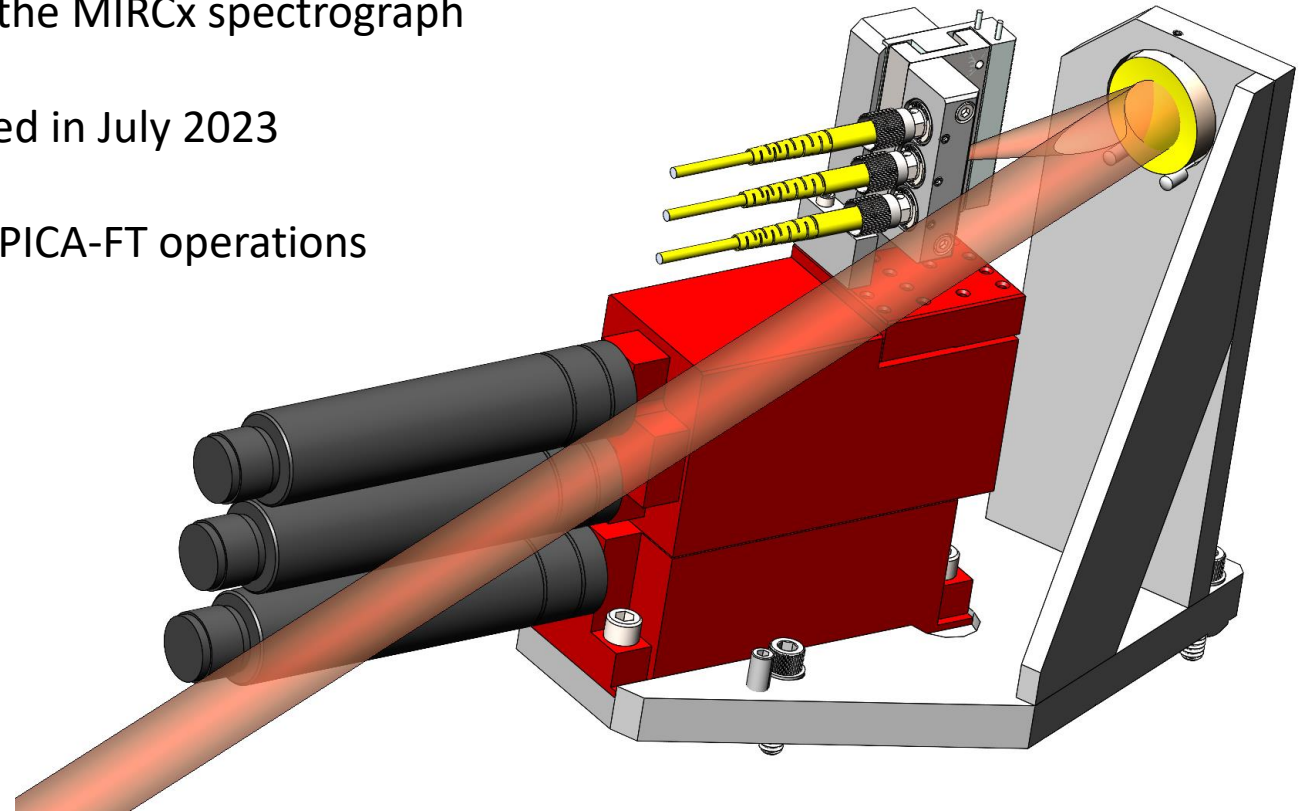

Conclusions

- ADC are not yet operational: not critical except for stars with zenithal distance larger than 45°
- Final validation of LDC/VLDC/DDL for the perfect correction of longitudinal dispersions
- Permanent check of the quality of AO → this is one of the most critical aspects for SPICA-VIS
- Complete operation of SPICA-FT for pushing the performance

Summary of the runs after the integration



- 10-12 March 2022: tests of injection, AO. Poor seeing. 1 night lost
- 28-31 March 2022: bad weather, 4 nights lost
- 23-27 April 2022: Optimisation of injection. 3 nights lost
- 27-31 May 2022: SPICA-FT control loops + software activities
- 21-25 June 2022: first 2T fringes, difficulties with dispersion. 2 nights lost
- 8-12 July 2022: continuation of 2T fringes
- 12-19 Aug 2022: Issues with dispersion, baseline solution
- 4-11 October 2022: First 2T data, dispersion not operational
- 4-8 Nov 2022: 3 nights lost - poor conditions, FT and dispersion issues
- 1-5 Dec 2022: 5 nights lost

- 1-5 March 2023: 5 nights lost
- 6-10 April 2023: 3.5 nights lost, continuing issues on dispersion
- 2-6 May 2023: 5 nights lost

Weather

2022: 18 nights lost over 33

2023: 13.5 nights lost over 15

+ after Aug 2022: issue of dispersion